

FIXTURE PERFORMANCE DATA

STANDARD

OPEN REFLECTOR TRIM TYPE

	DISTRIBUTION	DELIVERED LUMENS	WATTAGE	EFFICACY (lm/W)
P13	W	1238	12.3	101.0
	M	1006	12.3	82.2
	N	992	12.3	81.0
P25	W	2306	25.0	92.2
	M	1875	25.0	75.0
	N	1849	25.0	74.0
P40	W	3725	37.5	99.3
	M	3026	37.5	80.7
	N	2909	37.5	77.6
P54	W	5029	50.0	100.6

FLUSH LENS TRIM TYPE

	DISTRIBUTION	DELIVERED LUMENS	WATTAGE	EFFICACY (lm/W)
P13	W	1317	12.3	107.5
	M	1349	12.3	110.1
	N	1314	12.3	107.3
P25	W	2454	25.0	98.2
	M	2515	25.0	100.6
	N	2449	25.0	98.0
P40	W	3965	37.5	105.7
	M	4057	37.5	108.2
	N	3851	37.5	102.7
P54	W	5353	50.0	107.1

REGRESSED LENS TRIM TYPE

	DISTRIBUTION	DELIVERED LUMENS	WATTAGE	EFFICACY (lm/W)
P13	W	1266	12.3	103.3
	M	1313	12.3	107.2
	N	1307	12.3	106.7
P25	W	2358	25.0	94.3
	M	2447	25.0	97.9
	N	2436	25.0	97.4
P40	W	3809	37.5	101.6
	M	3949	37.5	105.3
	N	3831	37.5	102.2
P54	W	5143	50.0	102.9

TUNABLE WHITE

OPEN REFLECTOR TRIM TYPE

	DISTRIBUTION	DELIVERED LUMENS	WATTAGE	EFFICACY (lm/W)
P13	W	1088	12.3	88.8
	M	881	12.3	71.9
	N	869	12.3	70.9
P25	W	2157	22.0	98.0
	M	1752	22.0	79.6
	N	1684	22.0	76.5
P40	W	3285	37.5	87.6
P54	W	3810	43.5	87.6

FLUSH LENS TRIM TYPE

	DISTRIBUTION	DELIVERED LUMENS	WATTAGE	EFFICACY (lm/W)
P13	W	1153	12.3	94.1
	M	1181	12.3	96.4
	N	1150	12.3	93.9
P25	W	2295	22.0	104.3
	M	2349	22.0	106.8
	N	2230	22.0	101.4
P40	W	3496	37.5	93.2
P54	W	4056	43.5	93.2

REGRESSED LENS TRIM TYPE

	DISTRIBUTION	DELIVERED LUMENS	WATTAGE	EFFICACY (lm/W)
P13	W	1108	12.3	90.4
	M	1150	12.3	93.8
	N	1144	12.3	93.4
P25	W	2205	22.0	100.2
	M	2287	22.0	103.9
	N	2218	22.0	100.8
P40	W	3359	37.5	89.6
P54	W	3897	43.5	89.6

MULTIPLIER TABLES

COLOR TEMPERATURE			
	CCT	LUMENS	
		STANDARD	TUNABLE WHITE
80 CRI	2700K	0.92	0.83
	3000K	0.98	1.00
	3500K	1.00	0.99
	4000K	1.01	1.00
	5000K	1.02	0.98
90 CRI	2700K	0.76	-
	3000K	0.79	-
	3500K	0.82	-
	4000K	0.84	-
	5000K	0.88	-

OPEN REFLECTOR FINISH		
CATALOG NUMBER	REFLECTOR FINISH	CONVERSION FACTOR
CS	Clear semi-specular	1.00
SG	Satin-glow	0.92
GD	Gold	0.93
CG	Champagne Gold	0.96
PW	Pewter	0.86
SPC	Specular	1.02
RG	Rose Gold	0.88
WH	White, textured	0.89
BL	Black, textured	0.79

TRIM	
CATALOG NUMBER	CONVERSION FACTOR
AD	0.85
PD	0.85

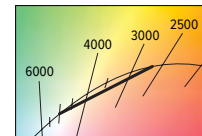

- Photometrics tested in accordance with IESNA LM-79. Results shown are based on 25°C ambient temperature.
- Standard results based on 3500K/80 CRI, actual lumens may vary +/-5%
- Tunable white results based on 4000K/80 CRI, actual lumens may vary +/-5%
- Use multiplier tables to calculate additional options.



6DS PoE | tunable **WHITE** 6" Downlight – Square

PHOTOMETRY

6DS-P25/835-POE PR-LW-OF-WH Total Luminaire Output: 2454 lumens; 25.0 Watts | Efficacy: 98.2 lm/W | 80 CRI; 3500K CCT

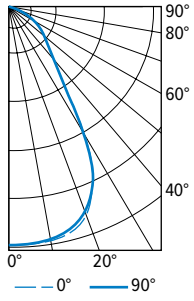

CANDLEPOWER DISTRIBUTION	VERTICAL ANGLE	HORIZONTAL ANGLE			ZONAL LUMENS
		0°	45°	90°	
	0	1658	1658	1658	
	5	1662	1654	1656	157
	15	1624	1603	1603	453
	25	1353	1492	1359	633
	35	619	998	621	498
	45	376	434	367	317
	55	237	243	235	215
	65	122	122	118	122
	75	47	46	45	51
	85	4	2	5	8
	90	0	0	0	

LUMEN SUMMARY	ZONE	LUMENS	% FIXTURE
	0 - 30	1244	51
	0 - 40	1742	71
	0 - 60	2274	93
	0 - 90	2454	100
	0 - 180	2454	100

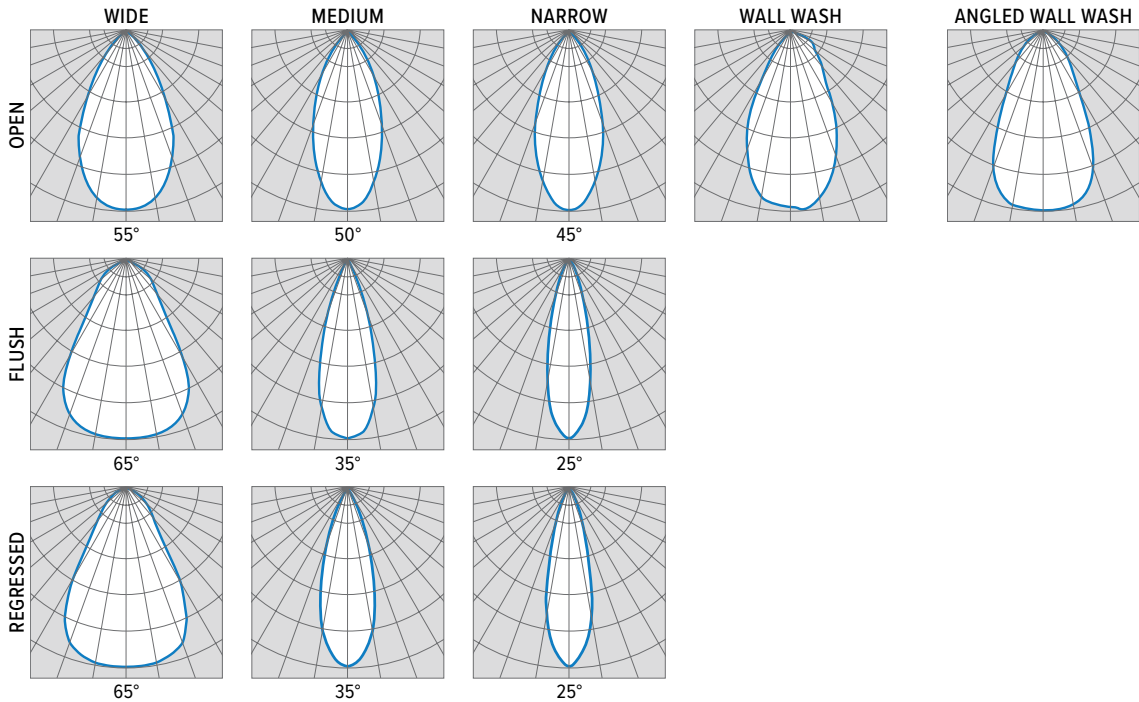

TRIM TYPE DETAILS

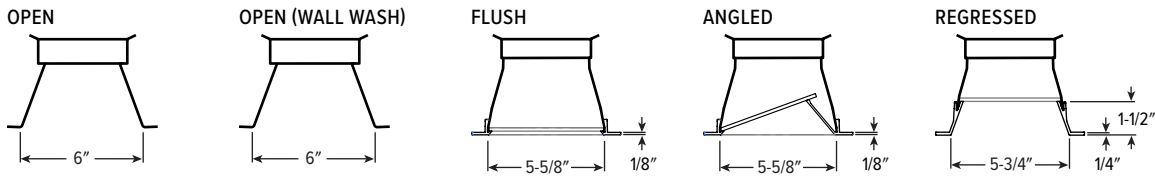

FLANGE TYPE DETAILS

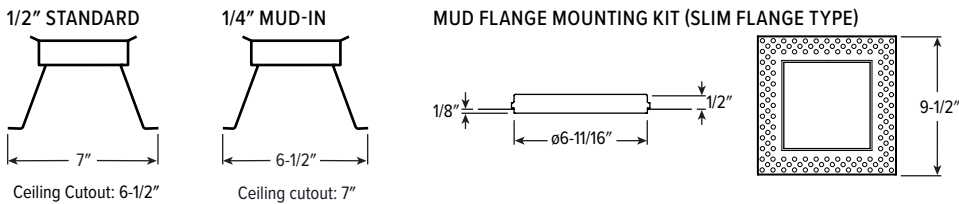

6DS PoE | tunable WHITE 6" Downlight – Square

REFLECTOR FINISH DETAILS

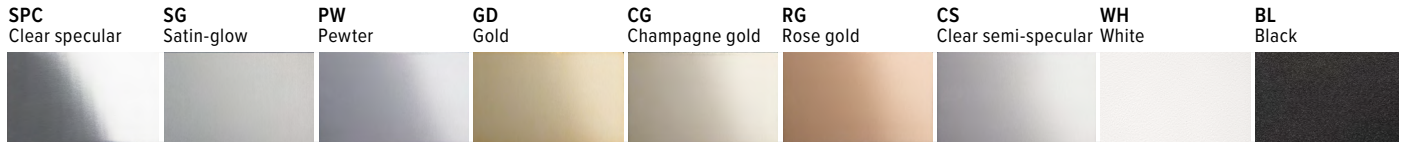

MOUNTING TYPE DETAILS

NEW CONSTRUCTION

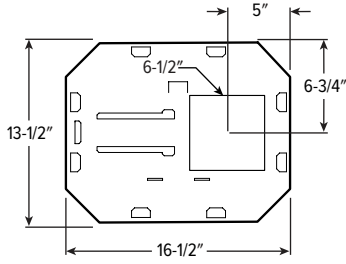

IC-RATED

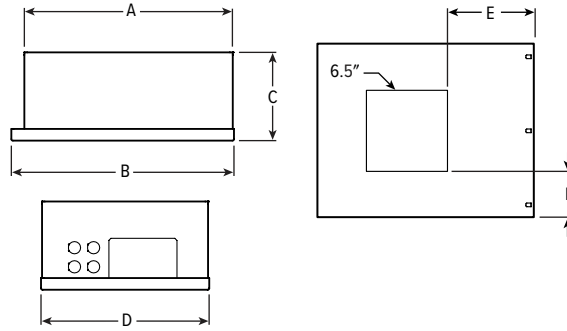

LUMENS	LENGTH					
	A	B	C	D	E	F
P13	15-3/16"	16"	6-3/8"	12-1/8"	6-1/4"	2-7/8"
P25	16-5/8"	17-1/2"	7-7/8"	14"	7"	3-3/4"

REMODEL

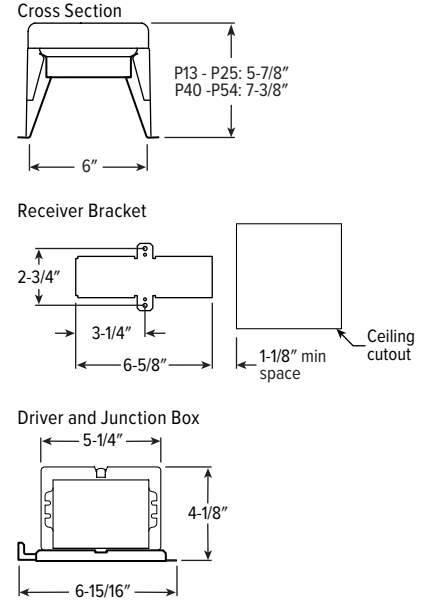

MOUNTING HARDWARE DETAILS

F1 Integral 2-position fixed pan bracket, universal bar hanger included

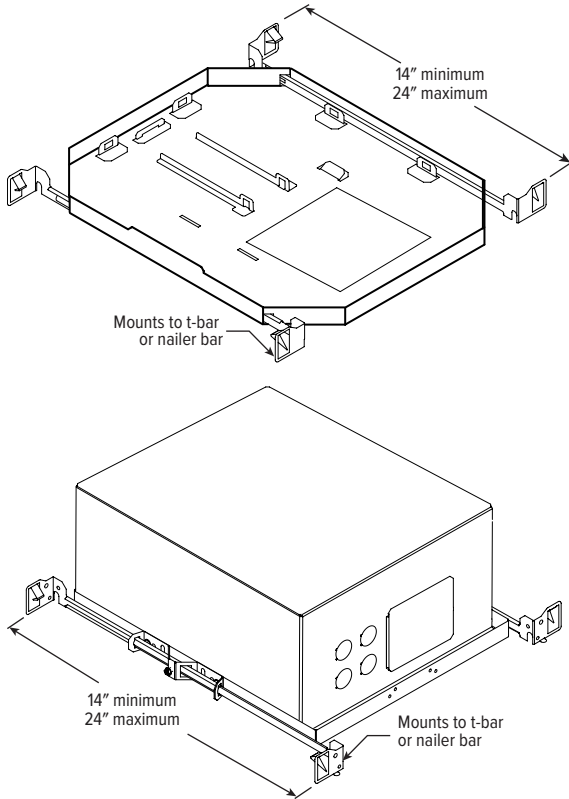

F1 with I Mounting Type

BA1 Adjustable butterfly pan bracket, bar hanger not included (N Mounting Type only)

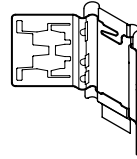

BA2 Adjustable butterfly pan bracket, heavy-duty universal bar hanger included (N Mounting Type only)

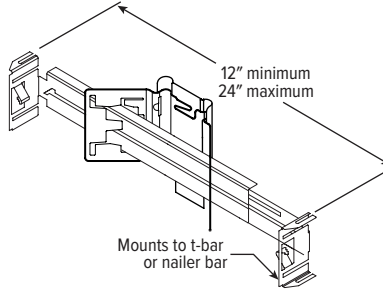

CA1 Adjustable caterpillar pan bracket, universal bar hanger included (N Mounting Type only)

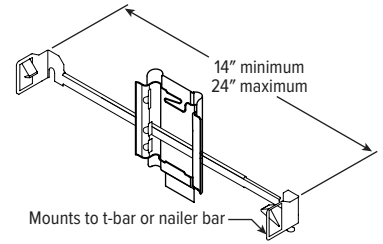

CA2 Adjustable caterpillar pan bracket, t-bar hanger included (N Mounting Type only)

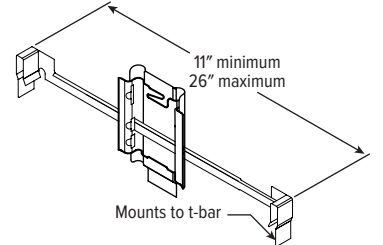

NODE CONNECTION DETAILS

Includes 24" cable with 4-position mating connector for Platformatics POE-LN2 node. See node spec sheet for details: platformatics.com/product/poe-ln2

