

CATALOG #: _____

TYPE: _____

PROJECT: _____

FEATURES

- Support human-centric design with adaptive, individualized lighting using tunable white light
- Low-profile depth for shallow plenum applications
- Diffuse lens provides smooth illumination for visual comfort
- Air return capability reduces number of unsightly ceiling vents for a cleaner appearance
- Surface mount kit preserves continuity
- Maximize energy savings with efficacies as high as 126 lm/W
- Made Right Here® in the USA

SPECIFICATIONS

- HOUSING/REFLECTOR** – Precision die-formed 22-gauge C.R.S.
- SHIELDING** – Frosted acrylic.
- FINISH** – Highly reflective non-glare matte white polyester powder coat bonded to phosphate-free, multi-stage pretreated metal. All parts painted after fabrication to facilitate installation, increase efficiency, and inhibit corrosion.
- ELECTRICAL** – High quality mid-power LED boards. L70 >50,000 hours per IES TM-21. Tunable White products use LEDs of multiple shade of white from single-CCT products at the same CCT. All CCTs are within 3 MacAdam ellipses.
- MOUNTING** – Designed for NEMA Type “G” 1” grid ceiling standard. For NEMA Type “NFG” and “SG” 9/16” grid installations, specify EQCLIPS option. Surface mount and drywall kit accessories available, shipped separately, see options.
- LISTINGS** –
 - cCSAus certified as luminaire suitable for dry or damp locations.
 - City of Chicago Environmental Air approved when specified with CP option.
- WARRANTY** – 5-year limited warranty, see hew.com/warranty.

ORDERING EXAMPLE: LT - 2 4 - L80/8TW - AF - OPTIONS - DALI - UNV

ORDERING INFO

SERIES	WIDTH	LENGTH	LUMENS ⁽¹⁾	CRI	CCT	SHIELDING
LT Static	1 1' ⁽³⁾	2 2' ⁽⁴⁾	1x4	8 80	TW Tunable white (3000K-5000K)	AF Frosted acrylic
LT-AR Air Return ⁽²⁾	2 2'	4 4'	L28 2,800lm L47 4,700lm L63 6,300lm	9 90 ⁽⁵⁾	TW2 Tunable white (2700K-6500K)	
			2x2			
			L27 2,700lm L39 3,900lm L49 4,900lm			
			2x4			
			L50 5,000lm L64 6,400lm L80 8,000lm			

OPTIONS ⁽⁶⁾

- EM/7WRM** Remote mount 7-watt emergency battery ⁽⁸⁾
- EM/10W** 10-watt emergency battery ⁽⁹⁾
- EM/12W** 12-watt emergency battery ⁽¹⁰⁾
- EQCLIPS (L__)** Earthquake clips ⁽¹¹⁾
Additional lower lumen packages available. ⁽¹²⁾
Example: 5,800 lumens = LT-24-L64/8TW-(L58)
- CP** Chicago Plenum (CCEA)
- LT-14-SMK-W** Surface mount kit, 1'x4', white
- LT-22-SMK-W** Surface mount kit, 2'x2', white
- LT-24-SMK-W** Surface mount kit, 2'x4', white
- DFK-1248W** Drywall kit, 12" x 48", white
- DFK-2424W** Drywall kit, 24" x 24", white
- DFK-2448W** Drywall kit, 24" x 48", white

CONTROL ⁽⁷⁾

- DALI** Driver prewired for DALI applications
- DIM** Dimming driver with (1) 0-10V signal to control dimming and (1) 0-10V signal to control CCT
- DMX** Driver prewired for DMX applications
- PSQ** Lutron T-Series 2-channel tunable white 1%.

VOLTAGE

- 120** 120V
- 277** 277V
- UNV** 120-277V

NOTES

- Lumens based on 4000 CCT. Actual lumens may vary +/-5%, see page 2 for FIXTURE PERFORMANCE DATA. Additional lumen packages available, see options.
- Air return through side slots. Not available with surface mount or CP option.
- 4' length only.
- 2' width only.
- Extended lead times may apply. Consult factory for availability.
- See page 3 for SURFACE MOUNT KIT DETAILS. See page 4 for DRYWALL KIT (DFK) OPTIONS. See Technical Info for Power Entry details.
- See page 4 for CONTROL DETAILS.
- 120-277V only.
- 120-277V only.
- 120-277V only.
- 4 per fixture. Optional for 1" grid installations. Required for 9/16" grid mounting; LT is compatible with Williams earthquake clips only.
- Specify in increments of 100 nominal lumens. Option must be specified with next higher lumen package.



FIXTURE PERFORMANCE DATA

	LED PACKAGE	DELIVERED LUMENS	WATTAGE	EFFICACY (lm/W)
1x4	L28	2855	22.6	126.3
	L47	4721	39.6	119.3
	L63	6308	54.8	115.3
2x2	L27	2797	24.6	113.7
	L39	3901	32.5	120.1
	L49	4969	42.7	116.5
2x4	L50	5082	42.0	120.9
	L64	6443	54.7	117.7
	L80	8003	63.7	125.6

- Photometrics tested in accordance with IESNA LM-79. Results shown are based on 25°C ambient temperature.
- Wattage shown is average for 120V through 277V input.
- Results based on 4000K, 80 CRI, actual lumens may vary +/-5%
- Use multiplier table to calculate additional options.

MULTIPLIER TABLE

		COLOR TEMPERATURE			
		TW		TW2	
CCT	CRI	LUMENS	WATTAGE	LUMENS	WATTAGE
		2700K	80	-	-
3000K	80	0.95	1.04	0.95	1.01
3500K	80	0.98	1.02	0.98	1.00
4000K	80	1.00	1.00	1.00	1.00
5000K	80	0.96	1.04	1.02	1.00
6500K	80	-	-	1.01	1.04
2700K	90	-	-	0.93	1.02
3000K	90	0.91	1.03	0.95	1.01
3500K	90	0.96	1.01	0.98	1.00
4000K	90	1.00	1.00	1.00	1.00
5000K	90	1.03	1.03	1.03	1.00
6500K	90	-	-	1.02	1.04

TW

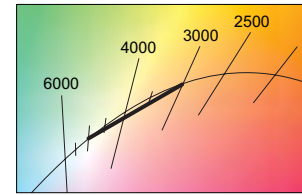

TW2

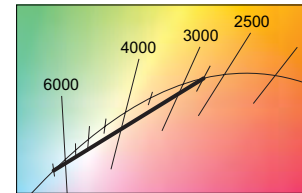

PHOTOMETRY

LT-14-L63/8TW-AF-DALI Total Luminaire Output: 6308 lumens; 55 Watts | Efficacy: 115 lm/W | 82.7 CRI; 3494K CCT

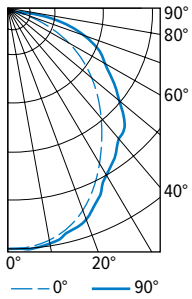

VERTICAL ANGLE	HORIZONTAL ANGLE			ZONAL LUMENS
	0°	45°	90°	
0	2397	2397	2397	
5	2408	2404	2404	228
15	2266	2284	2305	645
25	2012	2064	2114	943
35	1658	1754	1850	1088
45	1318	1472	1606	1121
55	939	1110	1259	989
65	610	793	882	755
75	316	433	401	425
85	84	98	74	114
90	0	0	0	

LUMEN SUMMARY	ZONE	LUMENS	% FIXTURE
	0 - 30	1815	29
	0 - 40	2903	46
	0 - 60	5013	80
	0 - 90	6308	100
	0 - 180	6308	100

LT-22-L49/8TW-AF-DALI Total Luminaire Output: 4969 lumens; 43 Watts | Efficacy: 116 lm/W | 84.9 CRI; 3544K CCT

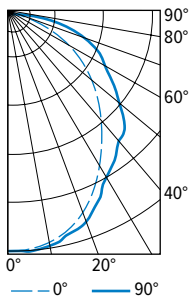

VERTICAL ANGLE	HORIZONTAL ANGLE			ZONAL LUMENS
	0°	45°	90°	
0	1716	1716	1716	
5	1716	1704	1705	162
15	1637	1641	1656	464
25	1494	1517	1552	701
35	1268	1337	1407	836
45	991	1119	1222	859
55	710	872	1005	779
65	459	638	791	626
75	234	413	546	417
85	53	116	113	125
90	0	0	0	

LUMEN SUMMARY	ZONE	LUMENS	% FIXTURE
	0 - 30	1328	27
	0 - 40	2163	44
	0 - 60	3802	77
	0 - 90	4969	100
	0 - 180	4969	100

LT-24-L80/8TW-AF-DALI Total Luminaire Output: 8003 lumens; 64 Watts | Efficacy: 126 lm/W | 84.9 CRI; 3544K CCT

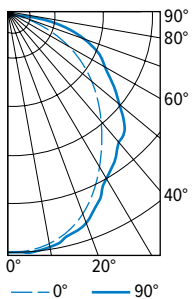

VERTICAL ANGLE	HORIZONTAL ANGLE			ZONAL LUMENS
	0°	45°	90°	
0	2840	2840	2840	
5	2821	2823	2824	268
15	2661	2686	2712	763
25	2357	2430	2499	1125
35	1991	2121	2245	1326
45	1625	1834	2022	1390
55	1140	1386	1602	1230
65	735	1019	1251	990
75	367	652	826	668
85	107	260	249	244
90	0	0	0	

LUMEN SUMMARY	ZONE	LUMENS	% FIXTURE
	0 - 30	2156	27
	0 - 40	3482	44
	0 - 60	6102	76
	0 - 90	8003	100
	0 - 180	8003	100



CROSS SECTIONS

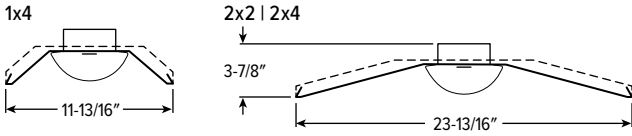

FIXTURE DETAILS

BACK VIEW

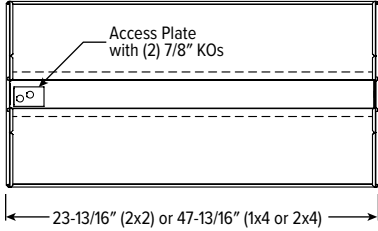

SIDE VIEW

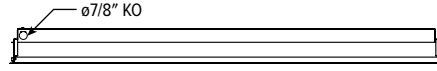

AIR RETURN

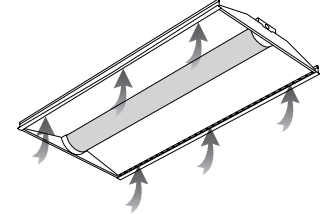

Total Air Return Space: 12-1/2" sq. (2x2) and 25-1/2" sq. (1x4 and 2x4)

SURFACE MOUNT KIT DETAILS



CROSS SECTIONS

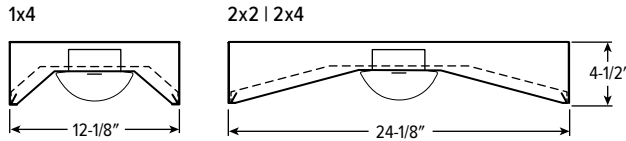

BACK VIEWS

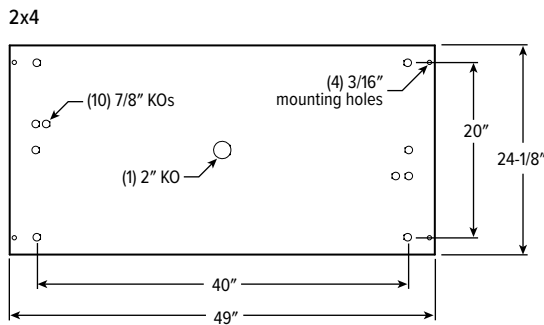
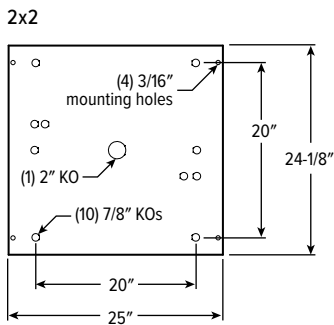
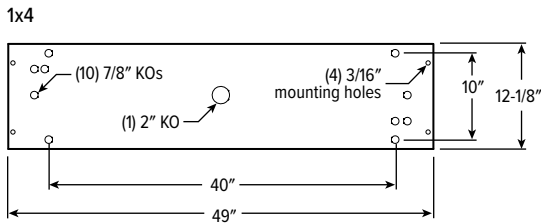

CONTROL DETAILS

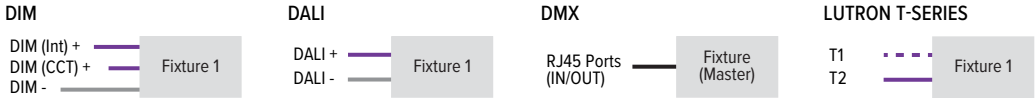

DRYWALL KIT (DFK) OPTIONS

ORDERING EXAMPLE: DFK - 24 24 W			
SERIES	WIDTH	LENGTH	FINISH
DFK Drywall Kit	See table below	See table below	W White AMW Anti-microbial white

TYPICAL INSTALLATION

Refer to table for dimensions.

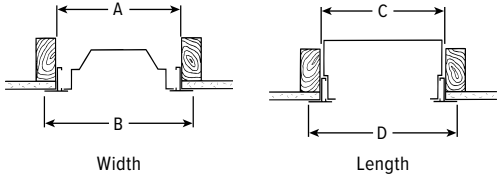

CATALOG NUMBER	NOMINAL SIZE	ROUGH-IN		FINISH TRIM SIZE	
		WIDTH (A)	LENGTH (C)	WIDTH (B)	LENGTH (D)
DFK-1248_	1' x 4'	12-3/8"	48-3/8"	13-5/16"	49-5/16"
DFK-2424_	2' x 2'	24-3/8"	24-3/8"	25-5/16"	25-5/16"
DFK-2448_	2' x 4'	24-3/8"	48-3/8"	25-5/16"	49-5/16"

