

# M4PR tunable WHITE 4.5" MRI Shallow Plenum Downlight – Round

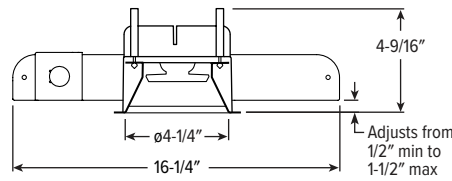

CATALOG #: \_\_\_\_\_

TYPE: \_\_\_\_\_

PROJECT: \_\_\_\_\_

## FEATURES

### TrimLock®

- Innovative TrimLock reflector retention system ensures trim remains flush with ceiling plane
- Tunable white from 2700K to 5000K CCT, minimum 80 CRI
- Designed with non-ferrous materials for MRI imaging suites
- IP65-rated die-cast trim includes easy-to-clean flush lens
- Beam angles ranging from 25° narrow to 65° wide for tailored performance
- 4 inch aperture is unobtrusive in small scale spaces
- Fully room-side accessible

## SPECIFICATIONS

- HOUSING** – Spun housing with forged aluminum heat sink. Aluminum splice compartment. Trim housing adjusts for ceiling thickness from 1/2" - 1-1/2".
- TRIMLOCK** – Innovative TrimLock reflector retention system ensures the trim remains flush with the ceiling plane.
- LENSED TRIM** – Die-cast aluminum frame with micro-prismatic, acrylic lens.
- ELECTRICAL** – High-performance Class 2 LED array. Modular quick-connect plug for easy field-connection of LED light assembly to splice compartment. Reported L70>50,000 hours. Tunable White products use LEDs of multiple CCTs and may produce a perceptibly different shade of white from single-CCT products at the same CCT. All CCTs are within 3 MacAdam ellipses. Remote mounted driver box must be located outside MRI room, RF filter required, provided by others.
- MOUNTING** – Recessed. Aluminum mounting pan for new construction or IC-rated enclosure. Remote mounted driver enclosure required, ordered separately, must be located outside MRI room.
- LISTINGS** –
  - cCSAus conforms to UL STD 1598; Certified to CAN/CSA STD C22.2 No. 250.0 for damp locations. LED light assembly conforms to UL 2108 for remote installation.
  - Suitable for wet location under covered ceiling when specified with WET/CC option.
  - IC-rated for direct contact with insulation when specified with I Mounting Type.
  - City of Chicago Environmental Air approved when specified with CP option.
  - Complies with ASTM-E283 when specified with ATH option.
  - RoHS compliant.
- WARRANTY** – 5-year limited warranty, see [hew.com/warranty](http://hew.com/warranty).

ORDERING EXAMPLE: M4PR - TL - L18/8TW - OPTIONS - LW - OF - WH - TRIM OPTIONS - N - F1M  
 HOUSING TRIM MOUNT.

## HOUSING

SERIES	LUMENS <sup>[1]</sup>	COLOR	OPTIONS
M4PR-TL	L11 1,100lm	8TW Tunable white (80 CRI, 2700K-5000K)	ATH Airtight construction
TrimLock	L18 1,800lm		CP Chicago plenum (CCEA) <sup>[2]</sup>

## TRIM <sup>[3]</sup>

TRIM TYPE	DISTRIBUTION <sup>[4]</sup>	FLANGE TYPE	REFLECTOR FINISH	TRIM OPTIONS
L Flush lens	W 65° Wide M 35° Medium N 25° Narrow	OF 1/2" standard flange SF 1/4" mud-in flange <sup>[5]</sup>	CS Clear semi-specular powder coat WH White texture powder coat BL Black texture powder coat	IP IP65 rated trim AD Diffuse acrylic lens <sup>[6]</sup> PD Diffuse 1/8" polycarbonate lens <sup>[7]</sup> WET/CC Wet location, covered ceiling listed <sup>[8]</sup> AM Anti-microbial <sup>[9]</sup>

## MOUNTING

### MOUNTING TYPE <sup>[10]</sup>

- N Open pan for new construction
- I IC-rated enclosure for new construction

### MOUNTING HARDWARE <sup>[11]</sup>

- FIM Factory-installed 2-position fixed pan bracket, universal bar hanger included <sup>[12]</sup>
- BA1M Adjustable butterfly pan bracket, aluminum, bar hanger not included <sup>[13]</sup>
- CA1M Adjustable caterpillar pan bracket, aluminum, universal bar hanger included <sup>[14]</sup>

## REMOTE DRIVER ENCLOSURE (ORDERED SEPARATELY) <sup>[15]</sup>

ORDERING EXAMPLE: M4PR - RDBTW1 - L18 - OPTIONS - DIM - UNV

SERIES	DRIVER BOX	DRIVER QTY.	LUMENS	OPTIONS	CONTROL <sup>[16]</sup>	VOLTAGE
M4PR	RDBTW Remote driver enclosure	1 7 2 8 3 9 4 10 5 11 6 12	L11 1,100lm L18 1,800lm	EM/10W 10-watt emergency battery <sup>[17]</sup> F Fuse kit	DALI Driver prewired for DALI applications DIM Dimming driver with (1) 0-10V signal to control dimming and (1) 0-10V signal to control CCT DMX Driver prewired for DMX applications PSQ Lutron T-Series 2-channel tunable white 1%. <sup>[18]</sup>	UNV 120-277V

## NOTES

- Nominal lumen output based on N distribution and WH finish, 4000K/80CRI. Actual lumens may vary +/-5%. See page 2 for FIXTURE PERFORMANCE DATA.
- I Mounting Type required.
- Trim ships separately.
- Beam angle based on WH reflector finish.
- For use with mud-in plaster construction only, supplied with mud flange installation kit. See page 3 for FLANGE TYPE DETAILS. Not available with ATH or IP options.
- Wide distribution only.
- Wide distribution only.
- Not available with PD trim option.
- WH and BL Reflector Finishes only.
- Mounting hardware required, ordered separately, see MOUNTING HARDWARE ordering info. See page 3 for MOUNTING TYPE DETAILS.
- See page 3 for MOUNTING HARDWARE DETAILS.
- Universal bar hanger ships uninstalled.
- N Mounting Type only.
- N Mounting Type only.
- Required. Ordered as a separate catalog number, ships separately. See page 4 for REMOTE DRIVER ENCLOSURE DETAILS (ORDERED & SHIPPED SEPARATELY).
- All drivers dimmed by single control signal.
- Available with RDB1 only.
- Not available with I Mounting Type.



# M4PR tunable WHITE 4.5" MRI Shallow Plenum Downlight – Round

## FIXTURE PERFORMANCE DATA

	DISTRIBUTION	DELIVERED LUMENS	WATTAGE	EFFICACY (lm/W)
L11	W	1025	14.6	70.4
	M	1193	14.6	82.0
	N	1184	14.6	81.4
L18	W	1664	24.0	69.3
	M	1936	24.0	80.7
	N	1922	24.0	80.1

### MULTIPLIER TABLES

COLOR TEMPERATURE		
CCT	LUMENS	WATTS
2700K	0.83	1.03
3000K	1.00	1.00
3500K	0.99	0.99
4000K	1.00	1.00
5000K	0.98	1.03

TRIM	
CATALOG NUMBER	CONVERSION FACTOR
AD	0.85
PD	0.85

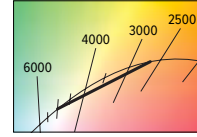

- Photometrics tested in accordance with IESNA LM-79. Results shown are based on 25°C ambient temperature.
- Wattage shown is based on 120V input.
- Results based on 4000K, 80 CRI, actual lumens may vary +/-5%
- Use multiplier tables to calculate additional options.

## PHOTOMETRY

**M4PR-TL-L18/8TW-DIM-UNV-LW-OF-WH** Total Luminaire Output: 1664 lumens; 24.0 Watts | Efficacy: 69.3 lm/W | 80.0 CRI; 4051K CCT

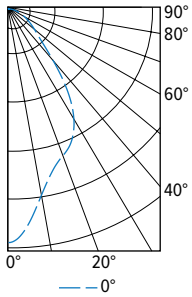

CANDLEPOWER DISTRIBUTION	VERTICAL ANGLE	HORIZONTAL ANGLE	ZONAL LUMENS
		0°	
	0	1332	
	5	1241	113
	15	961	272
	25	842	384
	35	602	369
	45	276	221
	55	161	145
	65	94	94
	75	47	50
	85	12	14
	90	2	

LUMEN SUMMARY	ZONE	LUMENS	% FIXTURE
	0 - 40	1138	68
	0 - 60	1505	90
	0 - 90	1664	100
	0-180	1664	100

**M4PR-TL-L18/8TW-DIM-UNV-LM-OF-WH** Total Luminaire Output: 1936 lumens; 24.0 Watts | Efficacy: 80.7 lm/W | 80.0 CRI; 4051K CCT

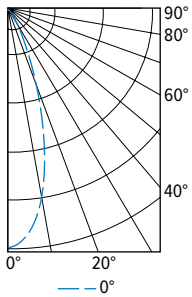

CANDLEPOWER DISTRIBUTION	VERTICAL ANGLE	HORIZONTAL ANGLE	ZONAL LUMENS
		0°	
	0	4549	
	5	4319	392
	15	2698	732
	25	915	433
	35	274	179
	45	113	90
	55	59	53
	65	34	34
	75	17	19
	85	4	5
	90	1	

LUMEN SUMMARY	ZONE	LUMENS	% FIXTURE
	0 - 40	1736	90
	0 - 60	1879	97
	0 - 90	1936	100
	0-180	1936	100

**M4PR-TL-L18/8TW-DIM-UNV-LN-OF-WH** Total Luminaire Output: 1922 lumens; 24.0 Watts | Efficacy: 80.1 lm/W | 80.0 CRI; 4051K CCT

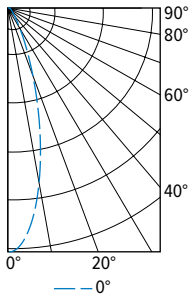

CANDLEPOWER DISTRIBUTION	VERTICAL ANGLE	HORIZONTAL ANGLE	ZONAL LUMENS
		0°	
	0	6450	
	5	5825	508
	15	2730	746
	25	729	351
	35	202	133
	45	95	75
	55	57	52
	65	34	34
	75	17	18
	85	4	5
	90	1	

LUMEN SUMMARY	ZONE	LUMENS	% FIXTURE
	0 - 40	1738	90
	0 - 60	1864	97
	0 - 90	1922	100
	0-180	1922	100



# M4PR tunable **WHITE** 4.5" MRI Shallow Plenum Downlight – Round

## TRIMLOCK DETAILS



## FLANGE TYPE DETAILS

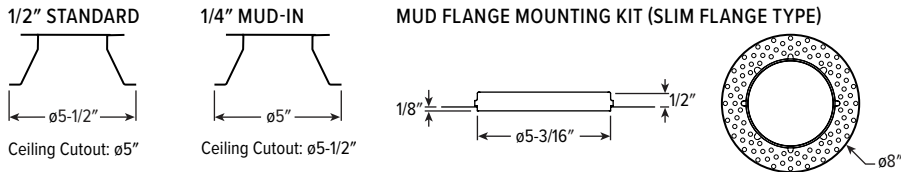

## REFLECTOR FINISH DETAILS

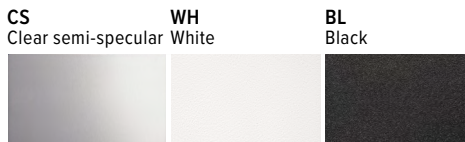

## MOUNTING TYPE DETAILS

### NEW CONSTRUCTION

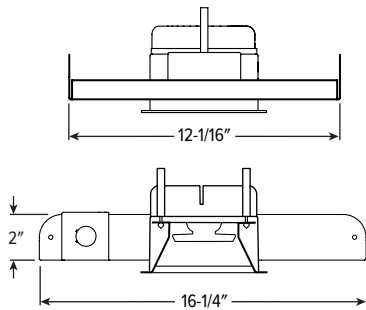

### IC-RATED

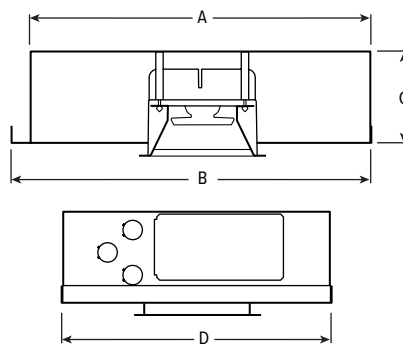

LUMENS	LENGTH			
	A	B	C	D
L11	15-3/16"	16"	4-1/8"	12-1/8"
L18	15-3/16"	16"	5-7/8"	12-1/8"

## MOUNTING HARDWARE DETAILS

**F1M** Factory-installed 2-position fixed pan bracket, universal bar hanger included

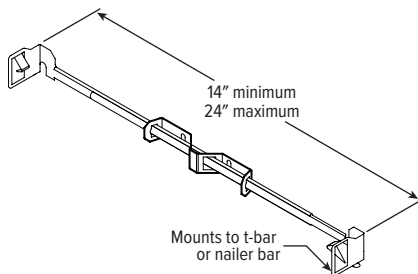

**BA1M** Adjustable butterfly pan bracket, aluminum, bar hanger not included (N Mounting Type only)

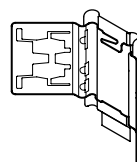

**CA1M** Adjustable caterpillar pan bracket, aluminum, universal bar hanger included (N Mounting Type only)

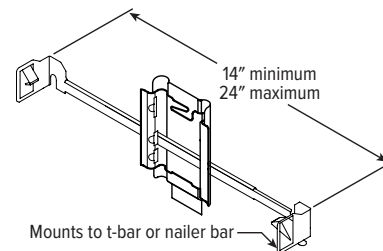

# M4PR tunable WHITE 4.5" MRI Shallow Plenum Downlight – Round

## REMOTE DRIVER ENCLOSURE DETAILS (ORDERED & SHIPPED SEPARATELY)

REMOTE DRIVER ENCLOSURE FOR SINGLE FIXTURE

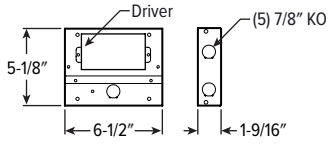

REMOTE DRIVER ENCLOSURE FOR SINGLE FIXTURE WITH EMERGENCY BATTERY

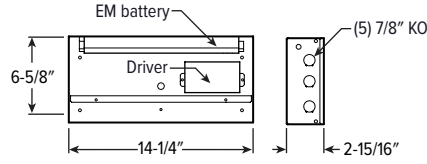

REMOTE DRIVER ENCLOSURE FOR 2 - 8 FIXTURES

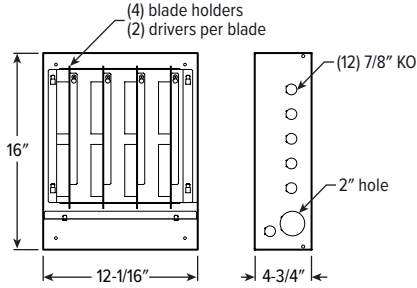

REMOTE DRIVER ENCLOSURE FOR 9 - 12 FIXTURES

