

M6PS dim to WARM 6" MRI Shallow Plenum Downlight – Square

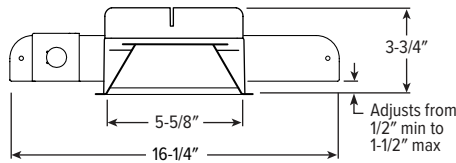
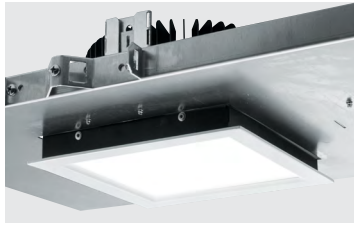

CATALOG #: _____

TYPE: _____

PROJECT: _____

FEATURES

- Dim to warm from 1800K to 3000K CCT, minimum 95 CRI
- Designed with non-ferrous materials for MRI imaging suites
- IP65-rated die-cast trim includes easy-to-clean flush lens
- Slim 5" depth for minimal plenum space applications
- Beam angles ranging from 30° narrow to 85° wide for tailored performance
- Square shape accentuates architectural styles
- Spring clip retention system eliminates trim sag
- Contemporary design provides glare-free illumination for a soft ceiling appearance
- Fully room-side accessible

SPECIFICATIONS

- **HOUSING** – Spun housing with forged aluminum heat sink. Aluminum splice compartment. Trim housing adjusts for ceiling thickness from 1/2" - 1-1/2".
- **LENSED TRIM** – Die-cast aluminum frame with micro-prismatic, acrylic lens.
- **ELECTRICAL** – High-performance Class 2 C.O.B. LED array. Modular quick-connect plug for easy field-connection of LED light assembly to driver. Reported L70>55,000 hours. Reported L90>55,000 hours. Estimated L70 = 200,000 hours. RF filter required, provided by others.
- **MOUNTING** – Recessed. Aluminum mounting pan for new construction or IC-rated enclosure. Remote mounted driver enclosure required, ordered separately, must be located outside MRI room.
- **LISTINGS** –
 - cCSAus conforms to UL STD 1598; Certified to CAN/CSA STD C22.2 No. 250.0 for damp locations. LED light assembly conforms to UL 2108 for remote installation.
 - Suitable for wet location under covered ceiling when specified with WET/CC option.
 - IC-rated for direct contact with insulation when specified with I Mounting Type.
 - City of Chicago Environmental Air approved when specified with CP option.
 - Complies with ASTM-E283 when specified with ATH option.
 - RoHS compliant.
- **WARRANTY** – 5-year limited warranty, see hew.com/warranty.

ORDERING EXAMPLE: **M6PS - L21/9DW - OPTIONS** - **LW - OF - WH - TRIM OPTIONS** - **N - F1M**

HOUSING

SERIES	LUMENS ⁽¹⁾	COLOR	OPTIONS
M6PS	L7 700lm	9DW Dim to warm (95 CRI, 1800K – 3000K)	ATH Airtight construction
	L13 1,300lm		CP Chicago plenum (CCEA) ⁽²⁾
	L21 2,100lm		

TRIM ⁽³⁾

TRIM TYPE	DISTRIBUTION ⁽⁴⁾	FLANGE TYPE	REFLECTOR FINISH	TRIM OPTIONS
L Flush lens	W 85° Wide	OF 1/2" standard flange	CS Clear semi-specular powder coat	IP IP65 rated trim
	M 35° Medium	SF 1/4" mud-in flange ⁽⁵⁾	WH White texture powder coat	AD Diffuse acrylic lens ⁽⁶⁾
	N 30° Narrow		BL Black texture powder coat	PD Diffuse 1/8" polycarbonate lens ⁽⁷⁾
				WET/CC Wet location, covered ceiling listed ⁽⁸⁾
				AM Anti-microbial ⁽⁹⁾

MOUNTING

MOUNTING TYPE ⁽¹⁰⁾

- N Open pan for new construction
- I IC-rated enclosure for new construction ⁽¹²⁾

MOUNTING HARDWARE ⁽¹¹⁾

- F1M Factory-installed 2-position fixed pan bracket, universal bar hanger included ⁽¹³⁾
- BA1M Adjustable butterfly pan bracket, aluminum, bar hanger not included ⁽¹⁴⁾
- CA1M Adjustable caterpillar pan bracket, aluminum, universal bar hanger included ⁽¹⁵⁾

REMOTE DRIVER ENCLOSURE (ORDERED SEPARATELY) ⁽¹⁶⁾

ORDERING EXAMPLE: **M6PS - RDBDW1 - L21 - OPTIONS - DIM1 - UNV**

SERIES	DRIVER BOX	DRIVER QTY.	LUMENS	OPTIONS	CONTROL ⁽¹⁷⁾	VOLTAGE	
M6PS	RDBDW Remote driver enclosure	1	7	L7 700lm	EM/10W 10-watt emergency battery ⁽¹⁸⁾	DIM1 1% dimming driver (0-10V signal to control dimming and CCT)	UNV 120-277V 347 347V ⁽²¹⁾
		2	8	L13 1,300lm			
		3	9	L21 2,100lm			
		4	10	F Fuse kit SDT Stepdown transformer ⁽¹⁹⁾			
		5	11				
		6	12		LUT Lutron Ecosystem enabled ⁽²⁰⁾		

NOTES

- Lumen output based on full light output, W distribution and WH finish, 3000K/95CRI. Actual lumens may vary +/-5%. See page 2 for FIXTURE PERFORMANCE DATA.
- I Mounting Type required
- Trim ships separately.
- Beam angle based on WH reflector finish.
- For use with mud-in plaster construction only, supplied with mud flange installation kit. See page 3 for FLANGE TYPE DETAILS. Not available with ATH or IP options.
- Wide distribution only.
- Wide distribution only.
- Not available with PD trim option.
- WH and BL Reflector Finishes only.
- Mounting hardware required, ordered separately, see MOUNTING HARDWARE ordering info. See page 3 for MOUNTING TYPE DETAILS.

- See page 3 for MOUNTING HARDWARE DETAILS.
- L13 lumen package max.
- Universal bar hanger ships uninstalled.
- N Mounting Type only.
- N Mounting Type only.
- Required. Ordered as a separate catalog number, ships separately. See page 4 for REMOTE DRIVER ENCLOSURE DETAILS (ORDERED & SHIPPED SEPARATELY).
- All drivers dimmed by single control signal.
- Available with RDB1 only.
- May be required for 347V, see product builder at hew.com/product-builder.
- Not available with I Mounting Type.
- Not available with EM batteries.



M6PS dim to WARM

6" MRI Shallow Plenum Downlight – Square

FIXTURE PERFORMANCE DATA

	DISTRIBUTION	DELIVERED LUMENS	CCT AT 100% (FULL OUTPUT)	CCT AT 1% (FULL DIM)	WATTAGE	EFFICACY (lm/W)
L7	W	825	3000K	1800K	14.0	59.0
	M	784			14.0	56.0
	N	752			14.0	53.7
L13	W	1447			23.4	61.9
	M	1374			23.4	58.8
	N	1318			23.4	56.4
L21	W	2141			37.7	56.8
	M	2030			37.7	53.8
	N	1948			37.7	51.6

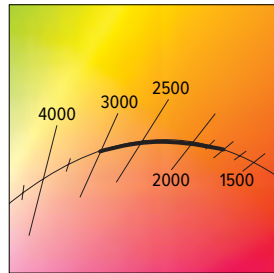

MULTIPLIER TABLE

TRIM	
CATALOG NUMBER	CONVERSION FACTOR
AD	0.85
PD	0.85

- Photometrics tested in accordance with IESNA LM-79. Results shown are based on 25°C ambient temperature.
- Wattage shown is based on 120V input.
- Results based on 3000K, 95 CRI, full output, actual lumens may vary +/-5%
- Use multiplier table to calculate additional options.

PHOTOMETRY

M6PS-L21/9DW-DIM1-UNV-LW-OF-WH Total Luminaire Output: 2141 lumens; 37.7 Watts | Efficacy: 56.8 lm/W | 95.0 CRI; 3000K CCT

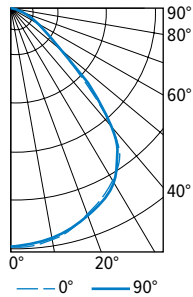

CANDLEPOWER DISTRIBUTION	VERTICAL ANGLE	HORIZONTAL ANGLE			ZONAL LUMENS
		0°	45°	90°	
	0	1059	1059	1059	
	5	1059	1054	1050	100
	15	1021	1014	1017	287
	25	950	940	948	436
	35	843	842	822	517
	45	503	635	498	427
	55	190	298	183	217
	65	91	110	92	101
	75	40	43	40	45
	85	8	7	8	9
	90	0	0	0	

LUMEN SUMMARY	ZONE	LUMENS	% FIXTURE
	0 - 30	823	38
	0 - 40	1340	63
	0 - 60	1984	93
	0 - 90	2141	100
	0 - 180	2141	100

M6PS-L21/9DW-DIM1-UNV-LM-OF-WH Total Luminaire Output: 2030 lumens; 37.7 Watts | Efficacy: 53.8 lm/W | 95.0 CRI; 3000K CCT

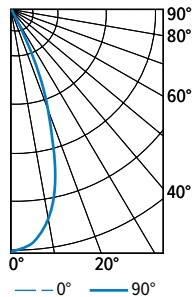

CANDLEPOWER DISTRIBUTION	VERTICAL ANGLE	HORIZONTAL ANGLE			ZONAL LUMENS
		0°	45°	90°	
	0	4173	4173	4173	
	5	4090	4062	4036	375
	15	2869	2893	2910	777
	25	936	981	979	480
	35	280	295	296	197
	45	117	125	124	99
	55	59	66	59	57
	65	29	32	29	30
	75	12	12	12	13
	85	1	2	1	3
	90	0	0	0	

LUMEN SUMMARY	ZONE	LUMENS	% FIXTURE
	0 - 30	1632	80
	0 - 40	1828	90
	0 - 60	1984	98
	0 - 90	2030	100
	0 - 180	2030	100

M6PS-L21/9DW-DIM1-UNV-LN-OF-WH Total Luminaire Output: 1948 lumens; 37.7 Watts | Efficacy: 51.6 lm/W | 95.0 CRI; 3000K CCT

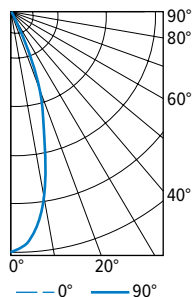

CANDLEPOWER DISTRIBUTION	VERTICAL ANGLE	HORIZONTAL ANGLE			ZONAL LUMENS
		0°	45°	90°	
	0	4728	4728	4728	
	5	4496	4461	4458	404
	15	2628	2652	2636	723
	25	820	875	861	421
	35	244	257	261	174
	45	115	126	124	96
	55	72	82	74	69
	65	39	44	41	42
	75	15	17	15	17
	85	1	1	1	3
	90	0	0	v0	

LUMEN SUMMARY	ZONE	LUMENS	% FIXTURE
	0 - 30	1547	79
	0 - 40	1721	88
	0 - 60	1886	97
	0 - 90	1948	100
	0 - 180	1948	100



M6PS dim to WARM

6" MRI Shallow Plenum Downlight – Square

FLANGE TYPE DETAILS

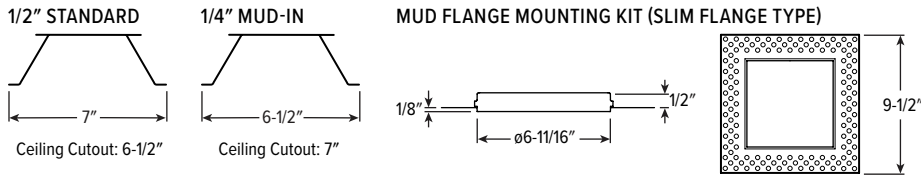

REFLECTOR FINISH DETAILS



MOUNTING TYPE DETAILS

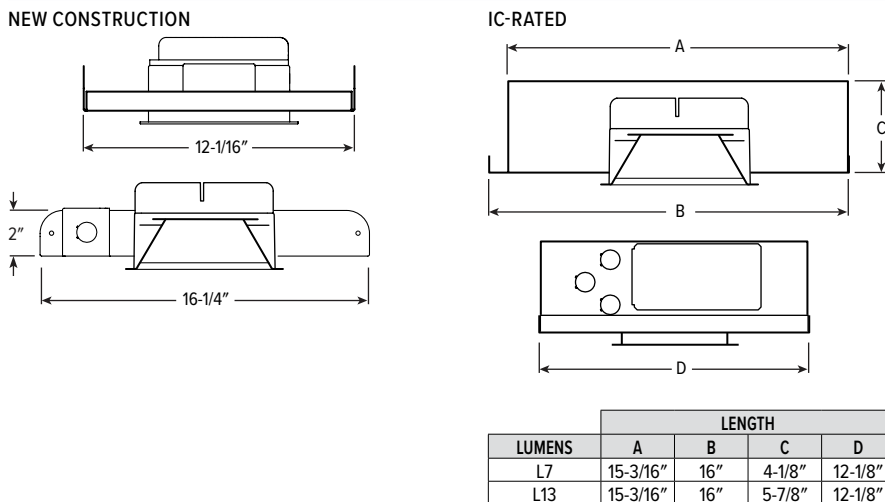

MOUNTING HARDWARE DETAILS

F1M Factory-installed 2-position fixed pan bracket, universal bar hanger included

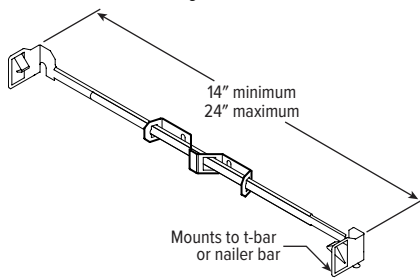

BA1M Adjustable butterfly pan bracket, aluminum, bar hanger not included (N Mounting Type only)

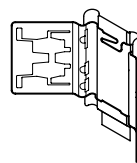

CA1M Adjustable caterpillar pan bracket, aluminum, universal bar hanger included (N Mounting Type only)

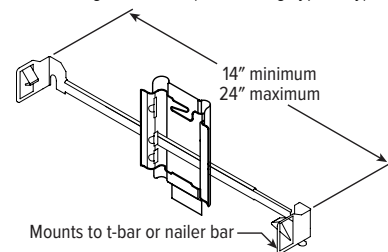

M6PS dim to WARM

6" MRI Shallow Plenum Downlight – Square

REMOTE DRIVER ENCLOSURE DETAILS (ORDERED & SHIPPED SEPARATELY)

REMOTE DRIVER ENCLOSURE FOR SINGLE FIXTURE

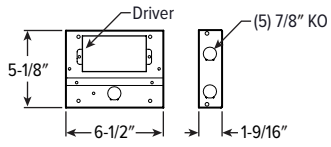

REMOTE DRIVER ENCLOSURE FOR SINGLE FIXTURE WITH EMERGENCY BATTERY

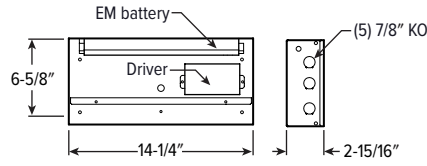

REMOTE DRIVER ENCLOSURE FOR 2 - 8 FIXTURES

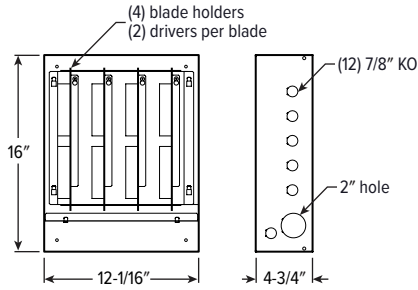

REMOTE DRIVER ENCLOSURE FOR 9 - 12 FIXTURES

