

OSA6S^{LED} 6" Aluminum Bollard – Square

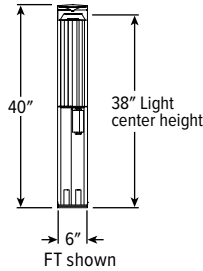
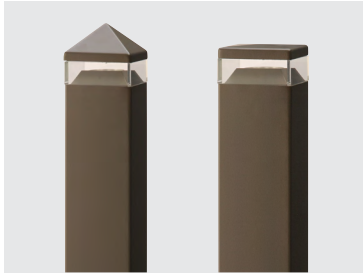

CATALOG #: _____

Type: _____

PROJECT: _____

FEATURES

- Suitable for a variety of low level lighting applications
- Available with a flat or peak top
- LEDs provide high-efficacy, good color rendering and a variety of color options
- Square aluminum bollard features a highly reflective bowl reflector with color-matched trim for effective light distribution and pleasing appearance day or night
- Finned, extruded aluminum heat sink for maximum heat dissipation
- Made Right Here[®] in the USA



ORDERING EXAMPLE: OSA6S - L20/840 - AC - FT - DBR - AB - OPTIONS - DIM - UNV

ORDERING INFO

SERIES	LUMENS ^[1]	CRI	CCT	SHIELDING/REFLECTOR	HOUSING TOP	
OSA6S	L10	1,000lm	8 80	27 2700K	AC Acrylic lens with bowl reflector	FT Flat top
	L15	1,500lm		30 3000K		PT Peak top
	L20	2,000lm		35 3500K 40 4000K		

FINISH OPTIONS^[2]

WHT	White (RAL #9003)
BLK	Black (RAL #9004)
DBZ	Dark bronze
DBR	Medium bronze
GRAY	Standard gray
GRN	Green (RAL #6005)
SLV	Satin aluminum (RAL #9006)
RAL#_____	Specify custom color

ANCHOR BOLTS^[3]

AB	Anchor bolts ^[4]
LAB	Less anchor bolts
PAB	Pre-shipped anchor bolts ^[5]

OPTIONS

SF	Single fuse ^[6]
DF	Double fuse ^[7]

SPECIFICATIONS

- HOUSING – Fabricated aluminum, minimum .125" thick.
- HOUSING TOP – Formed aluminum, minimum .125" thick.
- REFLECTOR – Spun aluminum upper and lower reflectors with clear specular finish.
- SHIELDING – UV stabilized clear acrylic sealed with silicone. Type V distribution.
- FINISH – Super durable polyester powder coat bonded to phosphate-free, multi-stage pretreated metal, meets and exceeds AAMA 2604 specifications for outdoor durability.
- ELECTRICAL – High quality mid-power LED board. L70 at 50,000 hours. Prewired at factory for easy field installation. Rated -40°F minimum starting temperature.
- MOUNTING – Three-point cast aluminum base. For accurate installation a fullscale mounting template is provided with every bollard and anchor bolt order.
- LISTINGS –
 - cETLus conforms to UL STD 1598 and UL STD 8750; Certified to CAN/CSA STD C22.2 No. 250.0. Suitable for wet locations.
 - Complies with the Buy American Act and other federal regulations. Request certification at hew.com/baa.
- WARRANTY – 5-year limited warranty, see hew.com/warranty.

DRIVER

DIM	Dimming driver prewired for 0-10V low voltage applications
DRV	Driver prewired for non-dimming applications

VOLTAGE

120	120V
208	208V
240	240V
277	277V
UNV	120-277V
347	347V
480	480V

NOTES

- ¹ Lumen output based on 4000K/80CRI and WHT Finish. Actual lumens may vary +/-5%.
- ² See page 2 for FINISH OPTIONS.
- ³ See page 2 for MOUNTING DETAILS.
- ⁴ Three 3/8" x 12" cast-in galvanized steel anchor J-bolts, shipped with fixture.

- ⁵ Three 3/8" x 12" cast-in galvanized steel anchor J-bolts.
- ⁶ 120V, 277V, or 347V only; must specify voltage.
- ⁷ 208V, 240V, or 480V only; must specify voltage.



OSA6S LED 6" Aluminum Bollard – Square

FIXTURE PERFORMANCE DATA

	DELIVERED LUMENS	WATTAGE	EFFICACY (lm/W)
L10	956	11.0	87
L15	1483	18.1	82
L20	2046	27.1	75

- Photometrics tested in accordance with IESNA LM-79. Results shown are based on 25°C ambient temperature.
- Wattage shown is average for 120V through 277V input.
- Results based on 4000K/80CRI and WHT Finish, actual lumens may vary +/-5%
- Use multiplier table to calculate additional options.

MULTIPLIER TABLES

COLOR TEMPERATURE	
CCT	CONVERSION FACTOR
2700K	0.91
3000K	0.97
3500K	1.00
4000K	1.00

FINISH	
CATALOG NUMBER	CONVERSION FACTOR
WHT	1.00
BLK	0.80
DBZ	0.80
DBR	0.81
GRAY	0.86
GRN	0.80
SLV	0.86

FOOTCANDLE ESTIMATOR & DISTRIBUTION

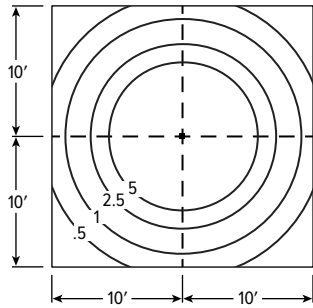

OSA6S-L20/835-AC-FT-WHT

- Delivered lumens: 2046
- Wattage: 27.1
- Efficacy: 75.5 lm/w
- CRI: 80
- CCT: 3500K

CROSS SECTIONS

Flat Top (FT) | Weight: 25 Lbs.

Peak Top (PT) | Weight: 25 Lbs.

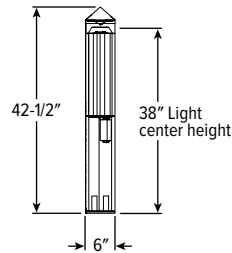
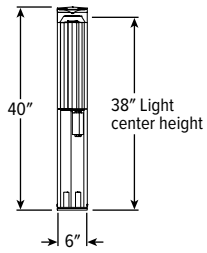

MOUNTING DETAILS

MOUNTING TEMPLATE

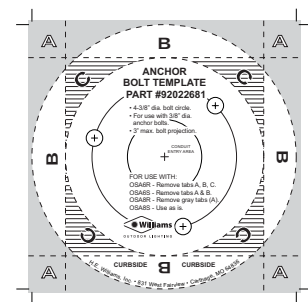

Mounting template is provided with each order. A pdf file (not to scale) of the mounting template is available at www.hew.com.

INSTALLATION

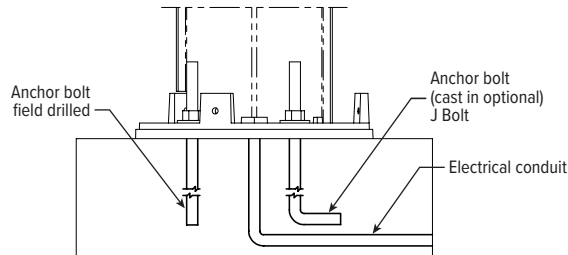

FINISH OPTIONS



For custom color, please specify RAL code or a manufacturer color with description. All custom colors other than RAL require two sample swatches, minimum 1" square.