

CATALOG #: \_\_\_\_\_

TYPE: \_\_\_\_\_

PROJECT: \_\_\_\_\_

**FEATURES**

- Create scalable, highly functioning smart buildings with Platformatics Power over Ethernet controls
- Tunable white from 3000K to 5000K CCT, minimum 80 CRI
- Timeless architectural design blends seamlessly into the space
- Multiple distributions elevate the SDI5 to a functional design that complements any environment
- Maximize energy savings with efficacies up to 145 lm/W
- Spacing ratio up to 2.4 evenly illuminates the environment with fewer luminaires
- Stand-alone and continuous row mounting
- Self-aligning joining method ensures straight, continuous rows
- Made Right Here® in the USA

**SPECIFICATIONS**

- **HOUSING** – 20-gauge die-formed C.R.S spot welded construction.
- **END CAPS** – 16-gauge C.R.S. with spot welded inner light stop, fastened with hidden machine screw fastener.
- **SHIELDING** – Diffuse acrylic or louver downlight options with clear acrylic uplight lens.
- **REFLECTIVE SURFACES** – 92% minimum average reflective white polyester powder coat on interior components.
- **FINISH** – Textured matte white polyester TGIC powder coat bonded to phosphate-free, multi-stage pretreated metal. All parts painted after fabrication to facilitate installation, increase efficiency, and inhibit corrosion.
- **ELECTRICAL** – High quality mid-power LED boards. L70 >50,000 hours per IES TM-21. Low-voltage DC fixture, to be fed by Class 2 power supply. Tunable White products use LEDs of multiple CCTs and may produce a perceptibly different shade of white from single-CCT products at the same CCT. All CCTs are within 3 MacAdam ellipses.
- **MOUNTING** – Suspended. 1/16" diameter adjustable steel leveling aircraft cable with two-point "Y" connector and mounting hardware provided. Fixtures join using (2) 8-32 machine screws and hex nuts.
- **LISTINGS** – cCSAus certified as luminaire suitable for dry or damp locations.
- **WARRANTY** – 5-year limited warranty, see [hew.com/warranty](http://hew.com/warranty).

**SYSTEM REQUIREMENTS**

- PoE-ready luminaires are connected to building power systems through network integration and require other components for complete PoE lighting system
- For additional PoE info, see [hew.com/poe](http://hew.com/poe)
- Consult factory for design support

**ORDERING EXAMPLE: SDI5 - 4 - P17/835 - DMA - 70U/30D - ACY/D48 - OPTIONS - POE PR**

**ORDERING INFO**

SERIES	LENGTH	LUMENS <sup>[1]</sup>	CRI	CCT
SDI5	Stand-alone – 4' & 8' nominal lengths, fixture ships assembled. Example: 4 = 4'	P8 800lm	8 80	27 2700K
		P17 1,700lm	9 90 <sup>[2]</sup>	30 3000K
	Row-mount – Lengths specified in 4' increments Example: 12 = 12'			35 3500K
				40 4000K
				50 5000K
<b>PRODUCT BUILDER</b> Simplify ordering & layout design with the Williams Linear Product Builder at <a href="http://hew.com/product-builder">hew.com/product-builder</a>				TW Tunable white (80 CRI, 3000K-5000K)

SHIELDING <sup>[3]</sup>	DISTRIBUTION <sup>[4]</sup>	MOUNTING (EXAMPLE: ACY/D48) <sup>[5]</sup>
<b>DMA</b> Diffuse matte acrylic lens, .080" thick (standard)	<b>100U</b> 100% uplight	Prefix Type Length
<b>144W/DMA</b> 7/16" deep, 44-cell cross-blade louver with diffuse matte acrylic overlay	<b>90U/10D</b> 90% uplight, 10% downlight	ACY/ D 1" grid & hardpan 24 24"
	<b>70U/30D</b> 70% uplight, 30% downlight	N 9/16" grid 48 48"
	<b>50U/50D</b> 50% uplight, 50% downlight	S Slot grid 96 96"
	<b>30U/70D</b> 30% uplight, 70% downlight	
	<b>10U/90D</b> 10% uplight, 90% downlight	
	<b>100D</b> 100% downlight	

OPTIONS <sup>[6]</sup>	CONTROL <sup>[7]</sup>
<b>FA</b> Frosted acrylic uplight lens recommended for use in suspension heights less than 24" <sup>[8]</sup>	<b>POE PR</b> Power over Ethernet, Platformatics-ready

**NOTES**

- <sup>1</sup> Lumens per foot, output based on 80 CRI, 3500K for single CCT and 4000K for TW. Actual lumens may vary +/-5%, see page 2 for FIXTURE PERFORMANCE DATA.
- <sup>2</sup> Extended lead times may apply. Consult factory for availability. Not available with tunable white.
- <sup>3</sup> See page 3 for FIXTURE DETAILS.
- <sup>4</sup> Nominal distributions shown. Refer to photometric tests for exact distributions.
- <sup>5</sup> See page 4 for MOUNTING DETAILS.
- <sup>6</sup> See page 4 for FINISH OPTIONS.
- <sup>7</sup> See page 4 for NODE CONNECTION DETAILS. For additional PoE info, see [hew.com/poe](http://hew.com/poe).
- <sup>8</sup> Available with 100U, 90U/10D, 70U/30D only.



## FIXTURE PERFORMANCE DATA

### STANDARD

	LED PACKAGE	DISTRIBUTION	DELIVERED LUMENS		TOTAL DELIVERED LUMENS	WATTAGE	EFFICACY (lm/W)
			UPLIGHT	DOWNLIGHT			
4'	P8	100U	2955	0	2955	23.2	127.4
		90U/10D	2884	320	3204	23.2	138.2
		70U/30D	2187	937	3124	23.2	134.7
		50U/50D	1514	1514	3028	23.2	130.6
		30U/70D	871	2033	2904	23.2	125.2
		10U/90D	274	2466	2740	22.3	122.9
	P17	100D	0	2687	2687	22.3	120.5
		100U	6314	0	6314	47.1	134.1
		90U/10D	6162	685	6847	47.1	145.4
		70U/30D	4673	2003	6675	47.1	141.7
		50U/50D	3235	3235	6470	47.1	137.4
		30U/70D	1862	4344	6206	47.1	131.8
8'	P8	100U	5911	0	5911	43.7	135.4
		90U/10D	5769	641	6410	43.7	146.8
		70U/30D	4374	1875	6249	43.7	143.2
		50U/50D	3029	3029	6057	43.7	138.8
		30U/70D	1743	4067	5810	43.7	133.1
		10U/90D	548	4933	5481	41.7	131.6
	P17	100D	0	5375	5375	41.7	129.0
		100U	12628	0	12628	94.2	134.1
		90U/10D	12324	1369	13694	94.2	145.4
		70U/30D	9345	4005	13350	94.2	141.7
		50U/50D	6470	6470	12941	94.2	137.4
		30U/70D	3723	8688	12412	94.2	131.8
		10U/90D	1171	10539	11710	94.1	124.4
		100D	0	11482	11482	94.1	122.0

### TUNABLE WHITE

	LED PACKAGE	DISTRIBUTION	DELIVERED LUMENS		TOTAL DELIVERED LUMENS	WATTAGE	EFFICACY (lm/W)
			UPLIGHT	DOWNLIGHT			
4'	P8	100U	2993	0	2993	25.1	119.2
		90U/10D	2921	325	3245	25.1	129.3
		70U/30D	2215	949	3164	25.1	126.0
		50U/50D	1533	1533	3067	25.1	122.1
		30U/70D	882	2059	2942	25.1	117.1
		10U/90D	278	2498	2775	21.5	129.4
	P17	100D	0	2721	2721	21.5	126.9
		100U	6309	0	6309	50.8	124.2
		90U/10D	6158	684	6842	50.8	134.7
		70U/30D	4669	2001	6670	50.8	131.3
		50U/50D	3233	3233	6465	50.8	127.3
		30U/70D	1860	4341	6201	50.8	122.1
8'	P8	100U	5935	0	5935	47.1	126.0
		90U/10D	5792	644	6436	47.1	136.6
		70U/30D	4392	1882	6274	47.1	133.2
		50U/50D	3041	3041	6082	47.1	129.1
		30U/70D	1750	4083	5833	47.1	123.8
		10U/90D	550	4953	5503	40.6	135.7
	P17	100D	0	5396	5396	40.6	133.1
		100U	12619	0	12619	101.6	124.2
		90U/10D	12315	1368	13684	101.6	134.7
		70U/30D	9338	4002	13340	101.6	131.3
		50U/50D	6465	6465	12931	101.6	127.3
		30U/70D	3721	8682	12402	101.6	122.1
		10U/90D	1170	10531	11701	89.0	131.5
		100D	0	11473	11473	89.0	128.9

### MULTIPLIER TABLES

	COLOR TEMPERATURE		
	CCT	LUMENS	
		STANDARD	TUNABLE WHITE
80 CRI	2700K	0.97	-
	3000K	0.99	0.95
	3500K	1.00	0.98
	4000K	1.03	1.00
	5000K	1.06	0.96
90 CRI	2700K	0.80	-
	3000K	0.82	-
	3500K	0.83	-
	4000K	0.86	-
	5000K	0.89	-

SHIELDING	
LENS	CONVERSION FACTOR
DMA	1.00
144W/DMA	0.95
FA	0.97

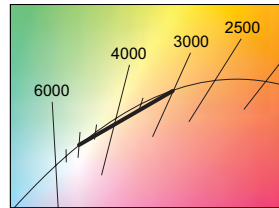

- Photometrics tested in accordance with IESNA LM-79. Results shown are based on 25°C ambient temperature.
- Wattage shown is average for 120V through 277V input.
- Standard results based on 3500K, 80 CRI, actual lumens may vary ±5%.
- Tunable white results based on 4000K, 80 CRI, actual lumens may vary ±5%.
- Use multiplier tables to calculate additional options.



# SDI5 PoE | tunable WHITE

Suspended Direct/Indirect

## PHOTOMETRY

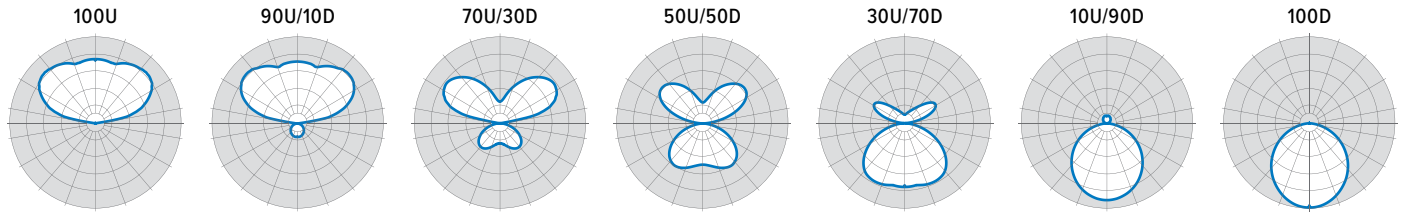

SDI5-4-P17/835-DMA-70U/30D Total Luminaire Output: 6675 lumens; 47.1 Watts | Efficacy: 141.7 lm/W | 85 CRI; 3500K CCT

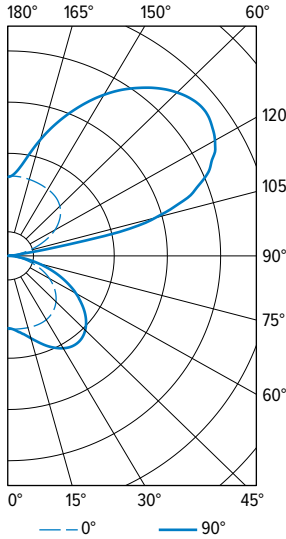

VERTICAL ANGLE	HORIZONTAL ANGLE			ZONAL LUMENS
	0°	45°	90°	
0	447	447	447	
5	453	451	457	44
15	457	486	524	139
25	458	537	620	249
35	444	563	675	351
45	402	534	649	408
55	333	453	542	396
65	238	322	385	312
75	125	168	200	175
85	22	32	38	39
90	0	3	4	
95	21	41	42	90
105	132	707	908	645
115	266	1022	1327	921
125	370	1147	1460	937
135	435	1112	1420	796
145	465	984	1254	583
155	478	810	1015	362
165	487	614	736	177
175	491	498	512	49
180	486	486	486	

LUMEN SUMMARY	ZONE	LUMENS	% FIXTURE
	0 - 40	784	12
	0 - 60	1588	24
	0 - 90	2115	32
	90 - 180	4560	68

## CROSS SECTIONS

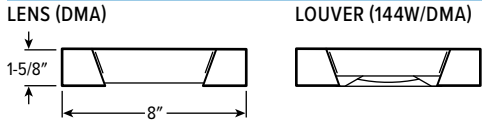

## FIXTURE DETAILS

### BACKVIEW

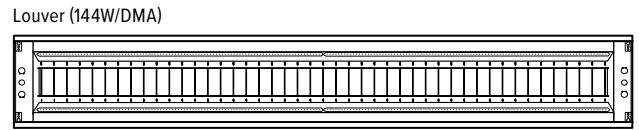
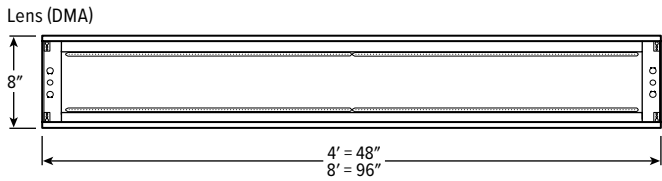

### LOUVER SHIELDING DETAIL

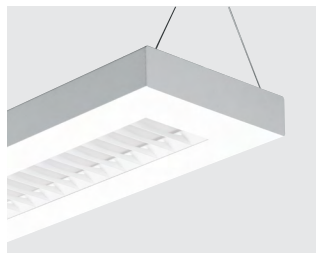

## MOUNTING DETAILS

### STANDARD HARDWARE (Grid and Hardpan)

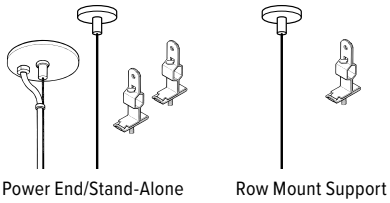

### CONTINUOUS ROW

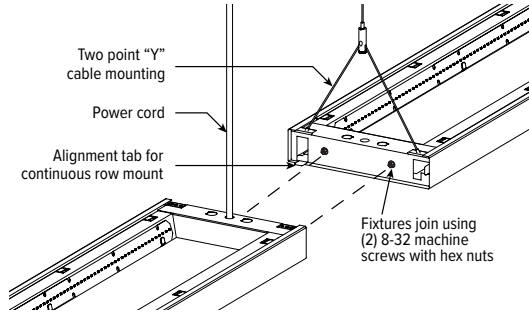

#### Notes:

- Fixtures are provided with adjustable length aircraft cables with two-point "Y" connectors and mounting hardware, must specify.
- Electrical supply is brought into the feeder fixture, either as part of a row or as a stand-alone unit. Joiner fixtures complete the row. One power drop per node required.

For continuous row mount, suspend fixture using aircraft cable at every fixture intersection and at both ends. Install end plates on each end of the continuous row. Depending on installation method, cable mounting may require additional counter-weights due to side-mounted driver.

## NODE CONNECTION DETAILS

Includes 24" cable with 4-position mating connector for Platformatics POE-LN2 node. See node spec sheet for details: [platformatics.com/product/poe-ln2](http://platformatics.com/product/poe-ln2)

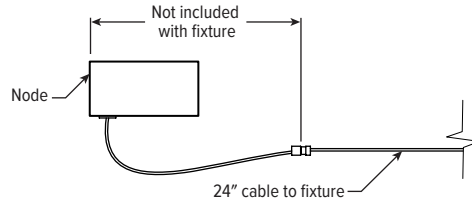

## FINISH OPTIONS

WHITE      BLACK      BRONZE      NICKEL      SILVER      ALUMINUM

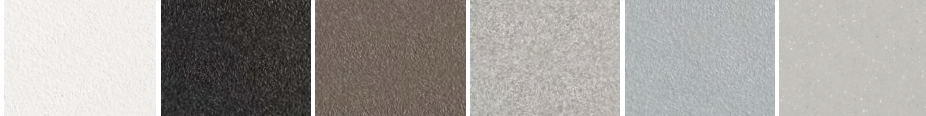

For custom color, please specify RAL code or a manufacturer code with description. All custom colors other than RAL require two sample swatches, minimum 1" square.

