

Straight Arm Front view
EPA: 1.00/Weight: 20 Lbs.

CATALOG #: _____

TYPE: _____

PROJECT: _____

FEATURES

- Contoured styling blends seamlessly with landscaping
- Precise light control with six standard NEMA distributions
- Versatile suite of architectural mounting arms
- Made Right Here[®] in the USA

SPECIFICATIONS

- HOUSING** – Die-cast aluminum enclosure, sealed to protect electrical components.
- THERMAL MANAGEMENT** – Integral die-cast aluminum heatsink provides passive thermal management. Rated -30°C to 40°C ambient operating temperature.
- OPTICAL SYSTEM** – Precision, injection-molded, refractive acrylic lensing produces standard NEMA floodlight distributions. Clear tempered glass lens.
- LED ASSEMBLY** – Circuit board design incorporates TVS (transient-voltage-suppression) diodes to protect against ESD events. ANSI 3000K, 4000K, and 5000K CCT, minimum 70 CRI LEDs.
- LED DRIVER** – Class 2 constant-current driver, 0-10V dimming.
- ELECTRICAL** – 120-277, 347, and 480 VAC input range; 50-60Hz; power factor >.90; THD <20% at full load. FCC Class A compliant. 10kA/10kV surge protection standard. L70 >50,000 hours per IES TM-21.
- FINISH** – Super durable polyester powder coat bonded to phosphate-free, multi-stage pretreated metal, meets and exceeds AAMA 2604 specifications for outdoor durability.
- MOUNTING** – Straight arm slip-fits ø2" (ø2-3/8" O.D.) tenon. Curved arm mounts to vertical surface or pole, downlight orientation only using cast adapter and mounting plate provided. Must be anchored to adequate structure that can safely support fixture weight. Fixture not designed to be mounted in horizontal orientation with glass facing upwards at 0 degrees.
- LISTINGS** –
 - cCSAus listed to STD 22.2 No 250.0 certified as luminaire suitable for wet locations.
 - DesignLights Consortium qualified product. Not all versions of this product may be DLC qualified, see the DLC Qualified Products List at www.designlights.org/QPL.
 - IP66 rated.
 - Meets the American National Standard for Roadway and Area Lighting Equipment – Luminaire Vibration (ANSI C1363.31-2010). Straight arm fixture only.
 - RoHS compliant.
- WARRANTY** – 5-year limited warranty, see hew.com/warranty.

ORDERING EXAMPLE: VF2 - L70/750 - MF - SR - DBZ - OPTIONS - DIM - UNV

ORDERING INFO

SERIES	LUMENS ^[1]	CRI	CCT	DISTRIBUTION ^[2]
VF2	L57 5,700lm	70	30 3000K	NS Narrow spot (3H x 3V)
	L70 7,000lm		40 4000K	MF Medium flood (5H x 5V)
	L88 8,800lm		50 5000K	WF Wide flood (6H x 6V)
				HS Horizontal spot (7H x 5V)
				VF Vertical flood (5H x 5V)
				HF Horizontal flood (7H x 5V)

MOUNTING^[3]

SR	Straight arm ^[5]	BLK	Black (RAL #9004)
CU	Curved arm ^[6]	DBZ	Dark bronze
		DBR	Medium bronze
		GRAY	Standard gray
		SLV	Satin aluminum (RAL #9006)
		WHT	White (RAL #9003)

FINISH OPTIONS^[4]

OPTIONS^[7]

PC	Factory-installed button-style photocell ^[8]
WG	Wireguard, 11-gauge tempered steel with chrome powder-coat finish. ^[9]
FVS	Flush vandal shield, 3/16" clear polycarbonate. ^[10]
VF1CS	Cutoff shield ^[11]
VF1FS	Full cutoff shield ^[12]

DRIVER

DIM Dimming driver prewired for 0-10V low voltage applications

VOLTAGE

120	120V
208	208V
240	240V
277	277V
UNV	120-277V
347	347V
480	480V

NOTES

- Lumen output based on 3500 CCT. Actual lumens may vary +/-5%, see page 2 for FIXTURE PERFORMANCE DATA. Additional lumen package available, see options
- See page 2 for DISTRIBUTION DETAILS.
- See page 2 for FINISH OPTIONS.
- See page 4 for MOUNTING OPTIONS – STRAIGHT ARM.
- Vertical surface mount, downlight orientation only, includes cast adapter and mounting plate

- See page 4 for OPTIONS DETAILS.
- 120V, 208V, 240V, or 277V only; must specify voltage
- Factory-installed
- Factory-installed
- Field-installed
- Field-installed



FIXTURE PERFORMANCE DATA

	WATTAGE	CURRENT (MA)	DISTRIBUTION	EFFICACY (lm/W)	FLUX (LM)	NEMA CLASSIFICATION	
						HORIZONTAL	VERTICAL
L57	53	530	NS	97	5109	3	3
			MF	97	5116	6	6
			WF	108	5673	6	6
			HS	98	5186	7	5
			VF	103	5404	5	5
			HF	102	5336	7	6
L70	69	700	NS	91	6292	3	3
			MF	92	6300	6	6
			WF	103	6986	6	6
			HS	93	6387	7	5
			VF	98	6655	5	6
			HF	96	6572	7	5
L88	97	950	NS	82	7923	3	3
			MF	82	7934	6	6
			WF	92	8797	6	6
			HS	83	8042	7	5
			VF	88	8381	5	5
			HF	86	8276	7	6

LUMEN MAINTENANCE

AMBIENT TEMP.	LUMEN PACKAGE	CCT	REPORTED L70 HOURS (TM-21)
25°C	L57	ALL	>60,000
	L70		
	L88	3000K	>51,000
		4000K & 5000K	>60,000
40°C	L57	ALL	>60,000
	L70		
	L88	3000K	>46,000
		4000K & 5000K	>60,000

- Efficacy and flux shown are for 5000K CCT. Flux multipliers: 0.96 for 4000K, 0.86 for 3000K
- Photometrics tested in accordance with IESNA LM-79. Results shown are at 25°C ambient temperature.

DISTRIBUTION DETAILS

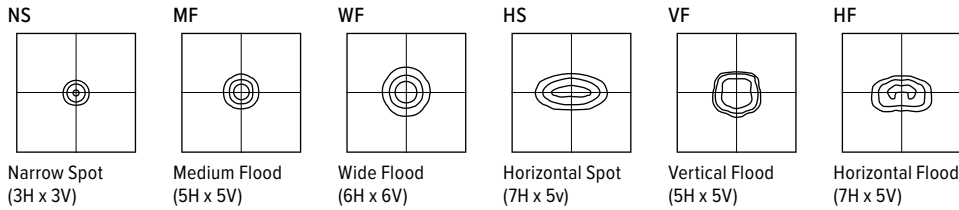

FIXTURE DETAILS

FIXTURE ADJUSTMENT DETAIL

Easily adjusts with locking teeth in 6° increments.

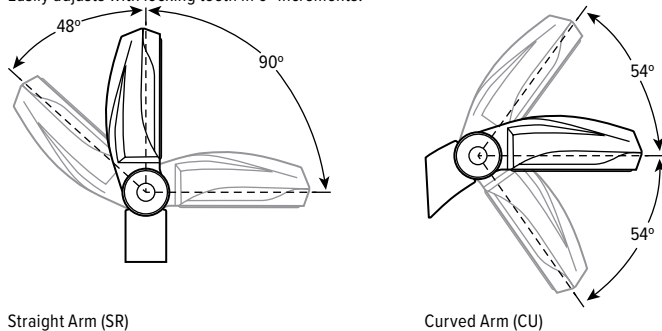

FINISH OPTIONS



For custom color, please specify RAL code or a manufacturer code with description. All custom colors other than RAL require two sample swatches, minimum 1" square.

VF2^{LED} Voltaire Small Architectural Flood Light

CROSS SECTIONS

STRAIGHT ARM

(EPA: 1.00/Weight: 20 lbs)

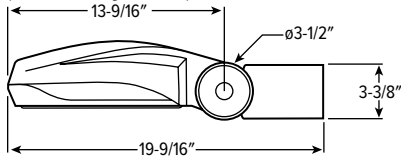

Side View

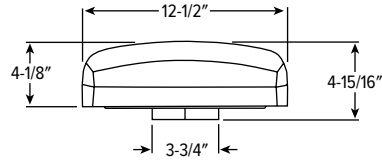

Front View

CURVED ARM

(EPA: 1.00/Weight: 20 lbs)

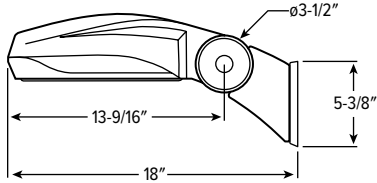

Side View

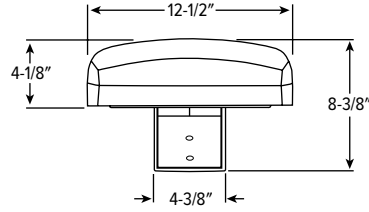

Front View

ARM MOUNTING DETAILS

STRAIGHT ARM (SR) MOUNTING

- Mounts horizontally or vertically to $\varnothing 2''$ ($\varnothing 2-3/8''$ O.D.) tenon.
- Up or down light applications.
- 360° rotation on mounting tenon.
- Additional mounting accessories available. See page 4 for MOUNTING OPTIONS – STRAIGHT ARM.

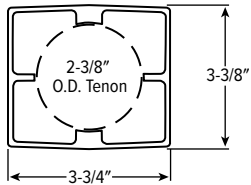

Fixture arm end view

CURVED ARM (CU) MOUNTING

- Mounts to vertical surface or pole, downlight orientation only, using cast adapter and mounting plate provided.
- Must be anchored to adequate structure that can safely support fixture weight.

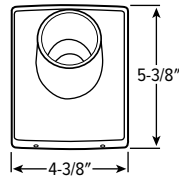

Adapter front view

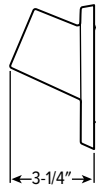

Adapter Side View

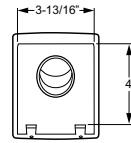

Adapter back view

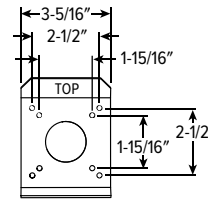



Mounting plate



VF2^{LED} Voltaire Small Architectural Flood Light

OPTIONS DETAILS

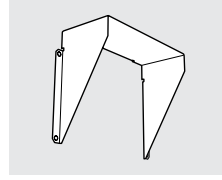
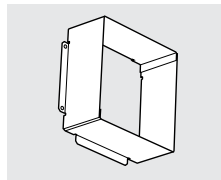
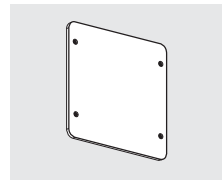
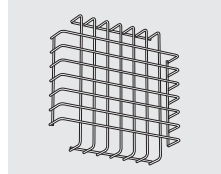
<p>FVS</p> 	<p>FVS Flush vandal shield, 3/16" clear polycarbonate, factory-installed. Fixture can accommodate only one face-mounted option.</p>	<p>WG</p> 	<p>WG Wireguard, 11-gauge tempered steel with chrome powder-coat finish, factory-installed. Fixture can accommodate only one face-mounted option.</p>
<p>PC</p> 	<p>PC Factory-installed button-style photocell, (120V, 208V, 240V, or 277V only; must specify voltage)</p>	<p>CUTOFF SHIELD</p> 	<p>VF2CS-___ Cutoff shield, 1/16" thick aluminum, field-installed. Must specify finish. Includes (4) #6-32 screws. 9-5/8" x 7-11/16" x 3-9/16" EPA: 0.42/Weight: 0.42 Lbs. Example: VF2CS-DBZ</p>
<p>FULL CUTOFF SHIELD</p> 	<p>VF2FS-___ Full cutoff shield, 1/16" thick aluminum, field-installed. Must specify finish. Includes (4) #6-32 screws. 9-5/8" x 9-5/8" x 3-9/16" EPA: 0.42/Weight: 0.82 Lbs. Example: VF2FS-DBZ</p>	<p>VANDAL SHIELD KIT</p> 	<p>VF2FVS Flush vandal shield kit, 3/16" clear polycarbonate, field-installed. Includes (4) #6-32 screws and clips. EPA: 0.02/Weight: 0.60 Lbs.</p>
<p>WIREGUARD KIT</p> 	<p>WG-VF2 Wireguard kit, 11-gauge tempered steel with chrome powder-coat finish, field-installed. Includes (8) #6-32 screws and clips. EPA: 0.18/Weight: 0.69 Lbs.</p>		

MOUNTING OPTIONS – STRAIGHT ARM

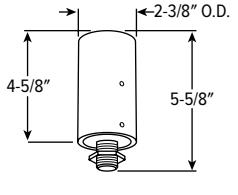
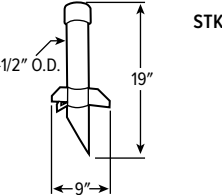
<p>THREADED ADAPTER</p> 	<p>VF2TA 1/2" NPS stainless steel threaded nipple with hex locknut on a cast aluminum anodized \varnothing2-3/8" O.D. adapter EPA: 0.00/Weight: 0.61 Lbs.</p>	<p>GROUND STAKE</p> 	<p>STK Ground stake, molded black plastic with integral splice compartment and 1/2" NPS threaded entry point for fixture mounting (requires VF2TA options, left)</p>
--	---	---	---



STRAIGHT ARM MOUNTING OPTIONS

NOTE: Tenons cannot be mounted in down orientation. Mounting accessories are for use with straight arm (SR) fixtures only.

TMHT

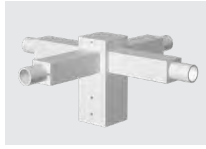

- POLE TOP TENON - HORIZONTAL FIXTURE MOUNT**
- Mounts on 2-3/8" - 3" pole top tenons
 - Round or square to match pole shape
 - Mounting configurations for one to four fixtures
 - Center tenon option available

Example: VF2-TMHT-SQ-T238-S-DBZ

DMHT



- DIRECT MOUNT - HORIZONTAL FIXTURE**
- Mounts to round or square poles
- Example: VF2-DMHT-SQ-S-DBZ

TMVT

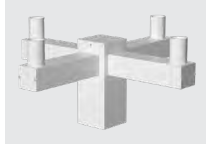

- POLE TOP TENON - VERTICAL FIXTURE MOUNT**
- Mounts on 2-3/8" - 3" pole top tenons
 - Round or square to match pole shape
 - Vertical fixture tenons
 - Mounting configurations for one to four fixtures
 - Center tenon option available

Example: VF2-TMVT-SQ-T238-S-DBZ

WMHT

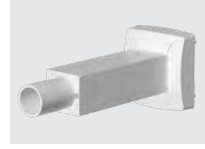

- WALL MOUNT - HORIZONTAL FIXTURE**
- Cast cover matches fixture aesthetics
- Example: VF2-WMHT-DBZ

HT



- HORIZONTAL POLE TOP TENON**
- Mounts on 2-3/8" - 3" pole top tenons
 - Round or square to match pole shape
 - Horizontal fixture tenons
 - Mounting configurations for one to four fixtures
 - Center tenon option available
- Example: VF2-HT-SQ-T238-S-DBZ

WMVT

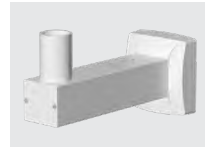

- WALL MOUNT - VERTICAL FIXTURE**
- Cast cover matches fixture aesthetics
 - Fixtures can be rotated 360° around tenon
- Example: VF2-WMVT-DBZ

VT



- VERTICAL POLE TOP TENON**
- Mounts on 2-3/8" - 3" pole top tenons
 - Round or square to match pole shape
 - Vertical fixture tenon
- Example: VF2-VT-SQ-T238-DBZ

SM



- SURFACE MOUNT**
- Mounts to any flat surface, with tenon in upward or horizontal orientation
 - Fixtures can be rotated 360° around tenon
- Example: VF2-SM-DBZ

DMVT

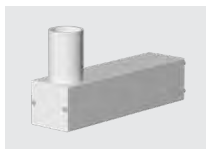

- DIRECT MOUNT - VERTICAL FIXTURE**
- Mounts to round or square poles
 - Fixtures can be rotated 360° around tenon
- Example: VF2-DMVT-SQ-S-DBZ

ST



- STANCHION MOUNT**
- Profile matches VF1 and VF2 arms
 - Stanchion arm base cover and fixture rotate 360° around base
- Example: VF2-ST-DBZ

ORDERING INFORMATION

EXAMPLE: VF2-TMVT-SQ-T238-S-DBZ-OPTIONS						
	SERIES	SIZE/SHAPE	TENON SIZE (BY OTHERS)	MOUNTING CONFIGURATION	FINISH OPTIONS	OPTIONS
TENON MOUNT	VF2-TMHT VF2-TMVT VF2-HT	SQ Square RD Round	T238 ø2-3/8" O.D. T278 ø2-7/8" O.D. T3 ø3" O.D.	S Single D90 Double @ 90° D180 Double @ 180° T90 Triple @ 90° T120 Triple @ 120° ¹ Q90 Quad @ 90°	BLK Black DBZ Dark bronze DBR Medium bronze GRAY Standard gray SLV Satin aluminum WHT White	CT Center tenon
	VF2-VT	SQ Square RD Round	T238 ø2-3/8" O.D. T278 ø2-7/8" O.D. T3 ø3" O.D.			
DIRECT MOUNT	VF2-DMVT VF2-DMHT	SQ Square pole 3R 3" round pole 4R 4" round pole 5R 5" round pole		S Single D90 Double @ 90° D180 Double @ 180° T90 Triple @ 90° T120 Triple @ 120° ¹ Q90 Quad @ 90°		
	VF2-WMHT VF2-WMVT VF2-SM VF2-ST					

¹ For RD option only



VF2^{LED} Voltaire Small Architectural Flood Light

LOAD DATA

MODEL NUMBER	ARM LENGTH ¹	MOUNTING CONFIGURATION	EPA ²	WEIGHT
VF2-SM		-	0.06	1.24
VF2-ST	14"	-	1.03	5.86
VF2-DMHT-SQ VF2-DMHT-RD	12"	S	0.87	5.19
		D90		
		D180		
		T90		
		T120		
		Q90		
VF2-DMVT-SQ VF2-DMVT-RD	14"	S	0.99	5.35
		D90		
		D180		
		T90		
		T120		
		Q90		
VF2-WMHT	12"	-	1.25	8.1
VF2-WMVT	14"	-	1.34	7.36
VF2-TMHT-RD	12"	S	1.44	10.84
		D90	2.18	14.57
		D180	2.23	14.57
		T90	2.92	19.21
		T120	2.82	19.21
		Q90	3.62	23.85
VF2-TMVT-RD	14"	S	1.56	9.04
		D90	2.45	12.79
		D180	2.45	12.79
		T90	3.25	16.54
		T120	3.16	16.54
		Q90	4.07	20.29
VF2-TMHT-SQ	12"	S	1.41	11.84
		D90	2	16.48
		D180	2.01	16.48
		T90	2.56	21.12
		Q90	3.12	25.76
VF2-TMVT-SQ	14"	S	1.56	10.95
		D90	2.36	14.7
		D180	2.13	14.7
		T90	2.86	18.45
		Q90	3.41	22.2
VF2-VT-RD	-	-	0.69	6.00
VF2-VT-SQ	-	-	0.83	7.75
VF2-HT-RD	-	S	0.69	5.74
		D90		6.19
		D180		6.19
		T90		6.64
		T120		6.64
		Q90		7.09
VF2-HT-SQ	-	S	0.83	7.65
		D90		8.1
		D180		8.1
		T90		8.55
		Q90		9.0

¹ Maximum arm length cannot exceed 28.188" long in any configuration.

² EPA is calculated for mounting options only.

